

NOTICE DE MONTAGE  
 ASSEMBLING INSTRUCTIONS  
 ISTRUZIONI DI MONTAGGIO  
 MONTAGEANLEITUNG  
 ISTRUÇÕES DE MONTAGEM  
 MANUAL DE MONTAJE  
 INSTRUKCJA MONTAŻU

# stolik nocny LUCA

04.02.2008

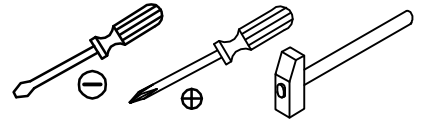
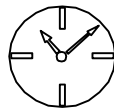

30 min

x1

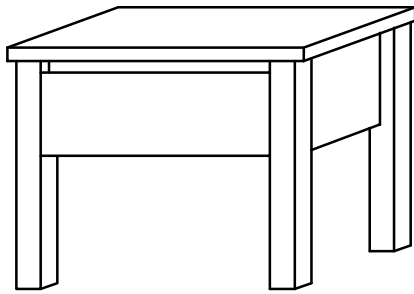

AVANT DE COMMENCER, SE  
 REPORTER AUX CONSEILS  
 DE MONTAGE EN ANNEXE

BEFORE STARTING, REFER  
 TO THE ASSEMBLING ADVICE  
 IN ANNEX

AVANTI DI COMINCIARE,  
 RIPORTATE AGLI CONSIGLI DI  
 MONTAGGIO

VOR DIE MONTAGE, BITTE  
 BEILIEGENDE ANWEISUNGEN  
 FOLGEN

ANTES DE COMERCAR, ADIAR  
 SE AOS CONSELHOS DE  
 MONTAGEM EM ANEXO

ANTES DE EMPEZAR  
 CONSULTE LOS CONSEJOS  
 PARA EL MONTAJE

PRZED ROZPOCZĘCIEM  
 ZAPOZNAĆ SIĘ Z ZAŁĄCZONĄ  
 INSTRUKCJĄ MONTAŻU

1

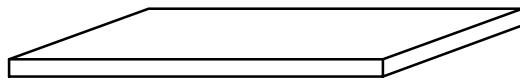

2PT

2PP

3

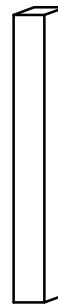
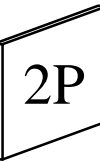

2LT

2LP

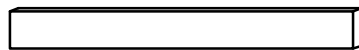

4

6

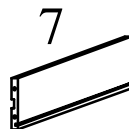

8

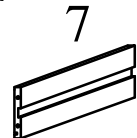

5



A x 1



B x 10



C x 16

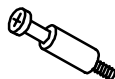

D x 16



E x 18

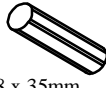

8 x 35mm

F x 4



6 x 35mm

G x 2

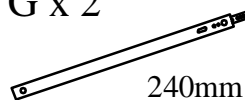

240mm

H x 2



4 x 9mm

I x 4





5,8 x 8mm

J x 4

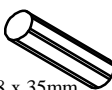

3,5 x 30mm

A x 1 	E x 14 8 x 35mm 	C x 14 
--	---	---

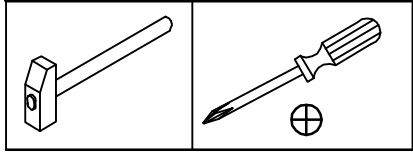

# I

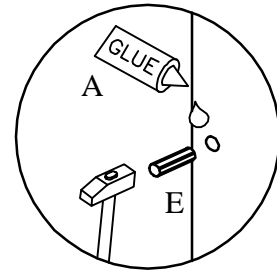
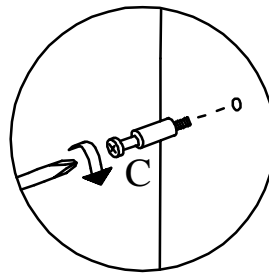
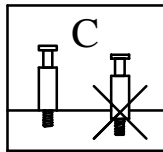

2LT

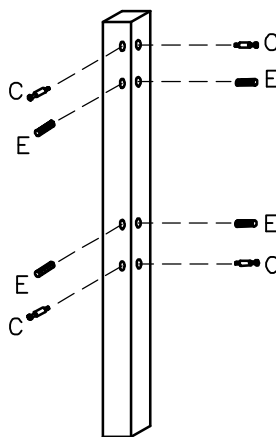

2LP

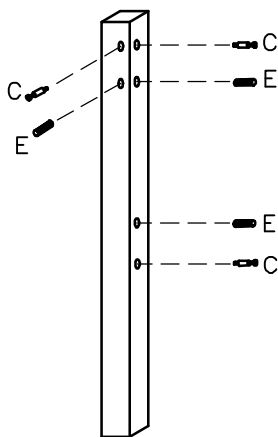

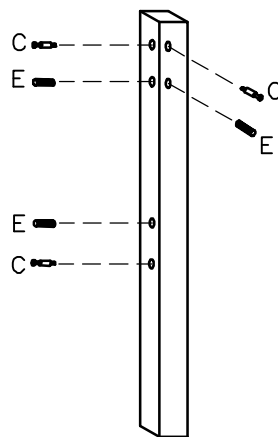

2PP

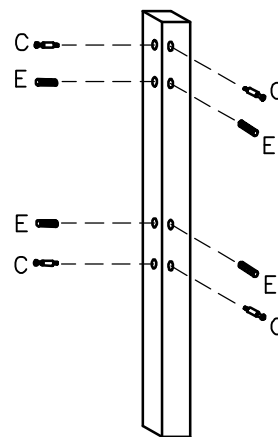

2PT

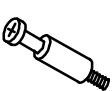

A x 1 	E x 4 8 x 35mm 	C x 2 
--	--	--

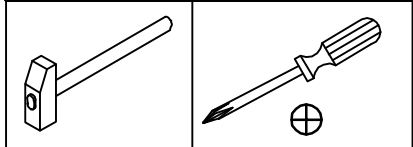

# II

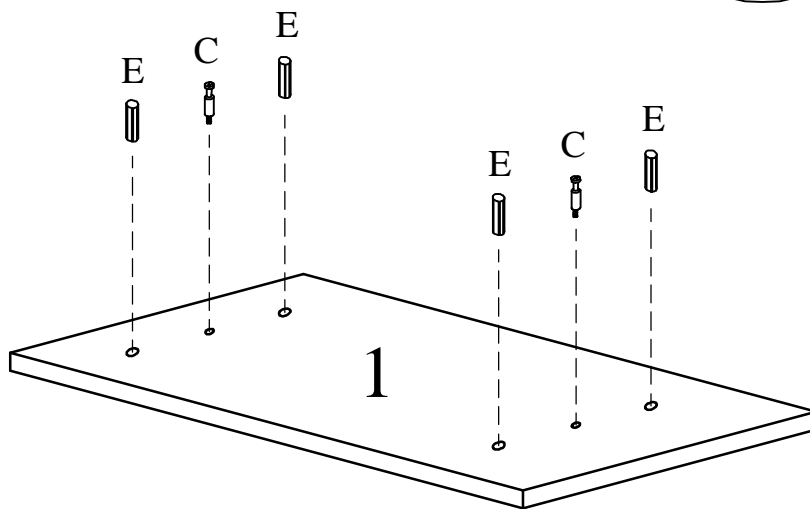
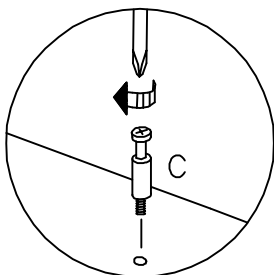
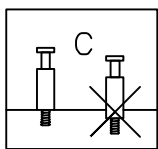
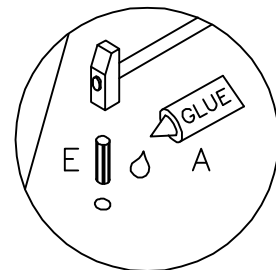

I x 4

G x 2

III

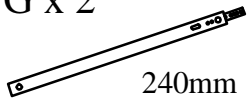

5.8 x 8mm

240mm

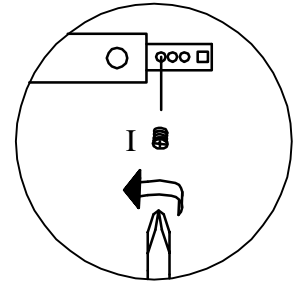
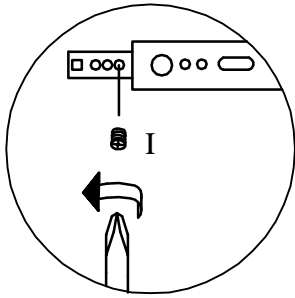
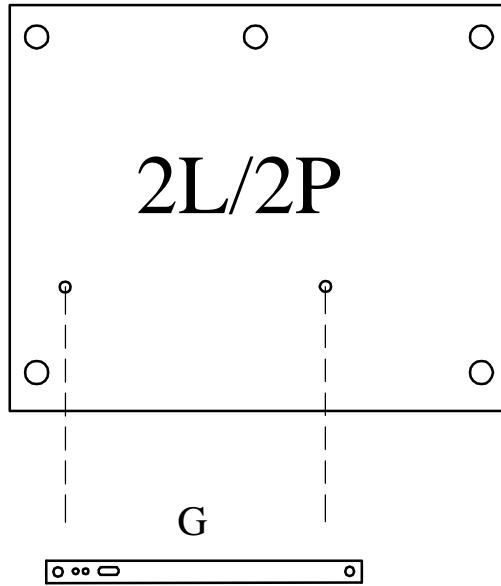
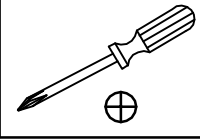

D x 8

IV

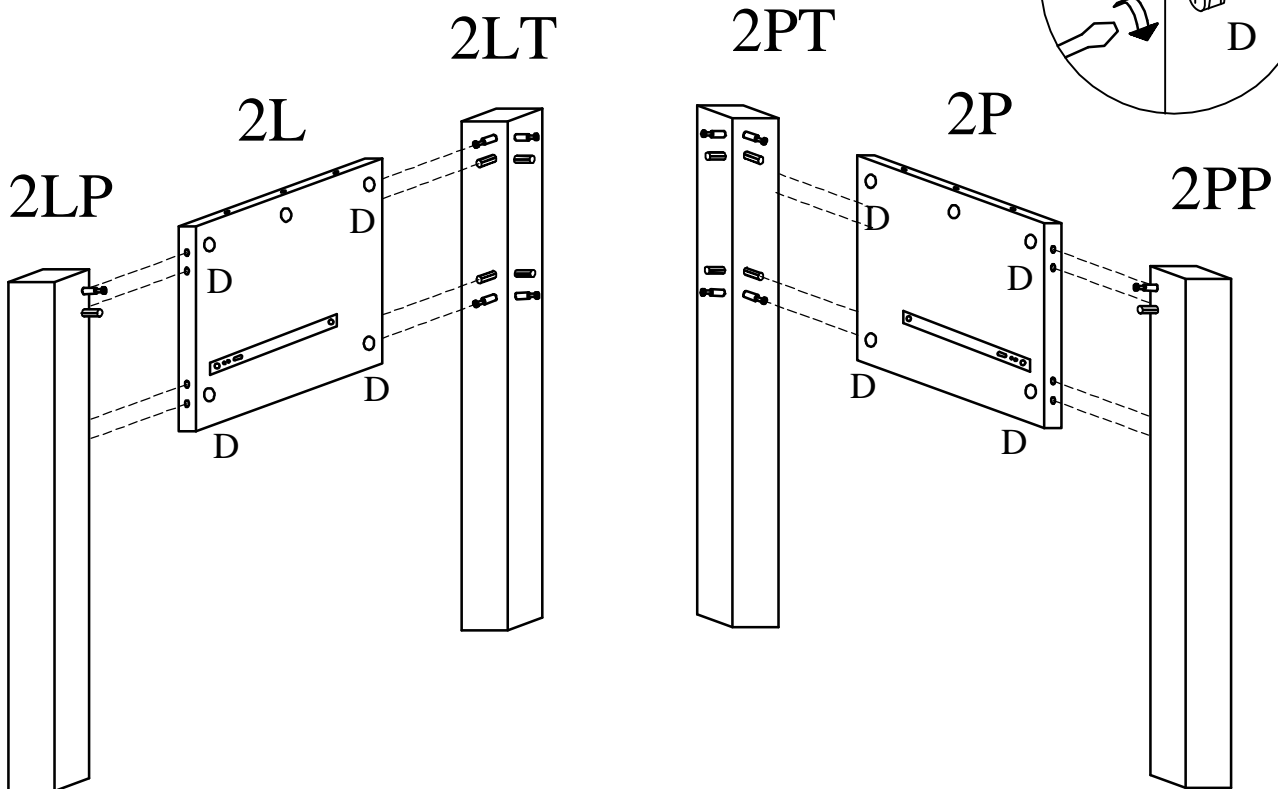
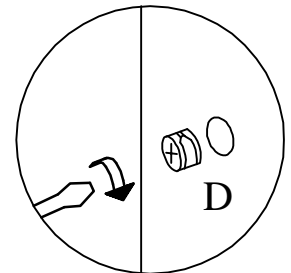
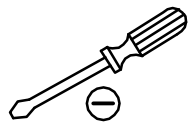

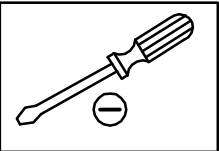
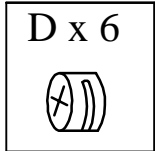

# V

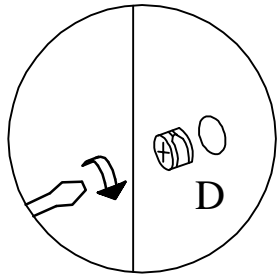

3

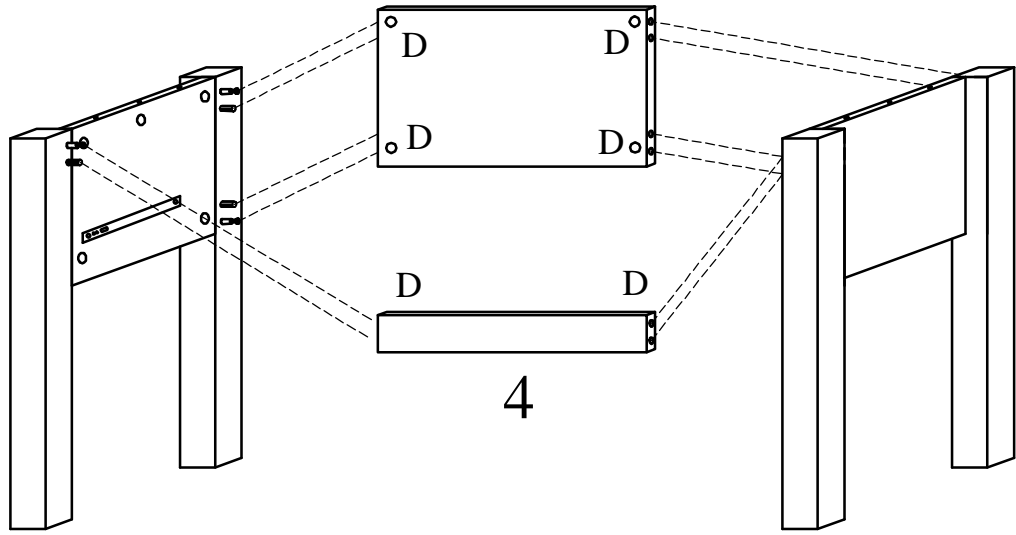

4

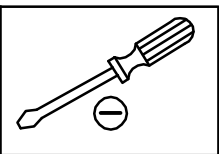
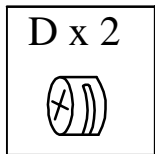



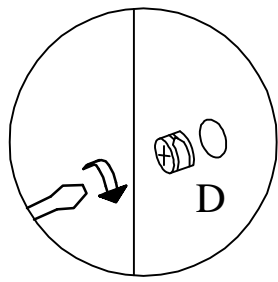

# VI

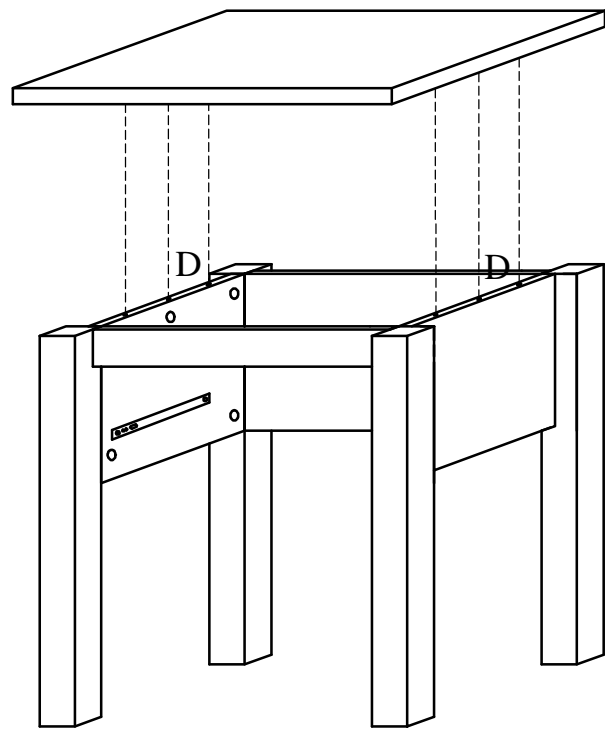

1



# VII

A x 1 	B x 3 	F x 4 6 x 35mm 	J x 4 3,5 x 30mm 
--	--	--	--

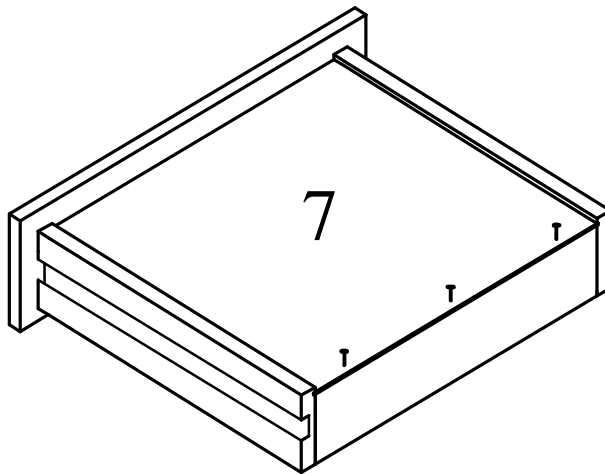
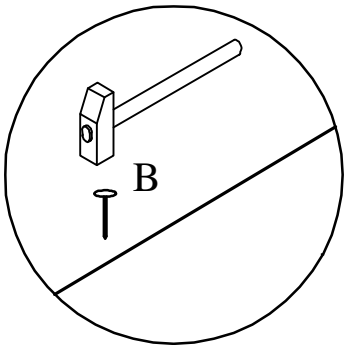
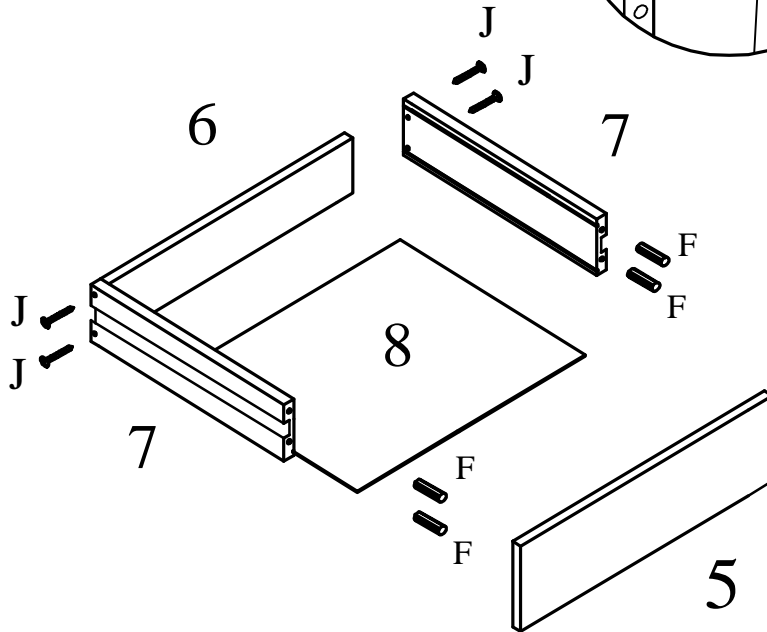
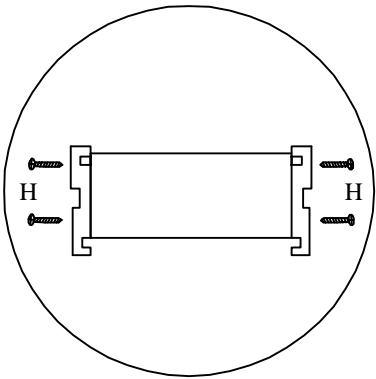
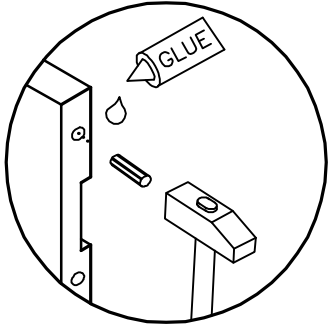
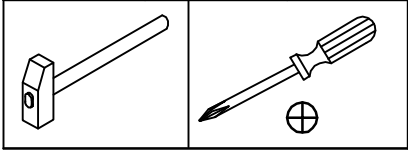

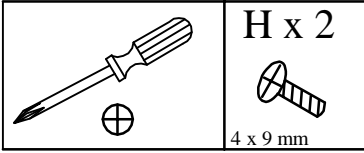

VIII

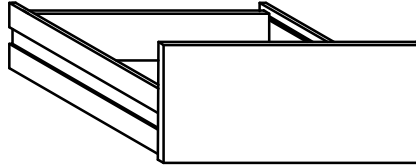
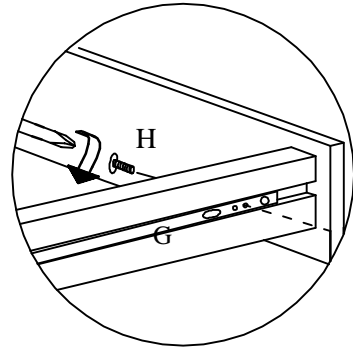

IX

